

VANK_PANEL

INSTALLATION ON SUPPORT UNITS

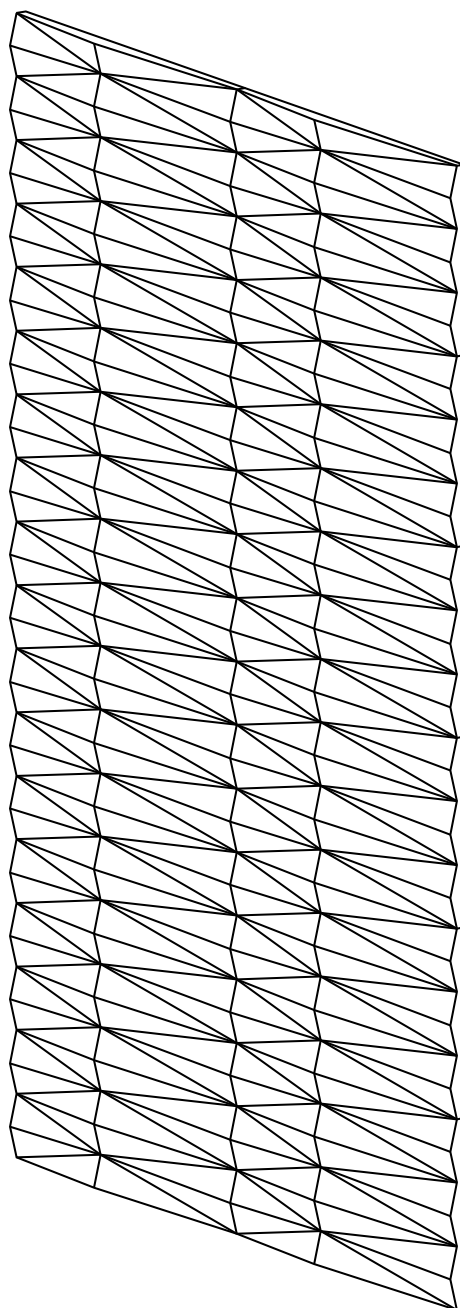

RECOMMENDED ARRANGEMENTS

**HORIZONTAL
DIAMOND**

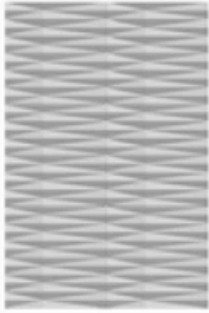

**HORIZONTAL
WAVE**

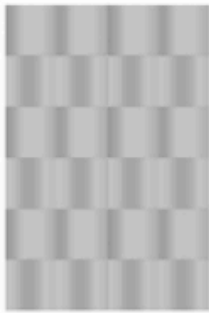

**HORIZONTAL
FLAT**



**HORIZONTAL
GLOBE**



**HORIZONTAL
LENS**



**HORIZONTAL
GLOBE+LENS**



**VERTICAL
DIAMOND**



**VERTICAL
WAVE**

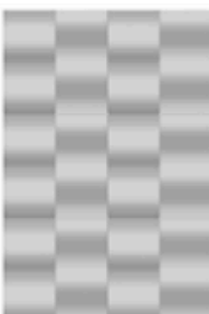

**VERTICAL
FLAT**



**VERTICAL
ELLIPSE_GLOBE**



**VERTICAL
ELLIPSE_COLUMN**

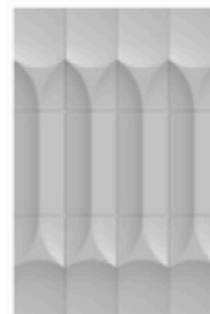

● CONNECTING ELEMENTS

8 X  frame connector

16 X  M6x10 DIN 7380-2 screw

2 X  suspension rail, length = 1500 mm - for vertical systems

or

 suspension rail, length = 2000 mm - for horizontal systems

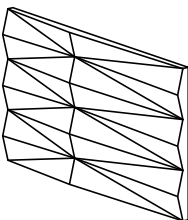
12 X  panel

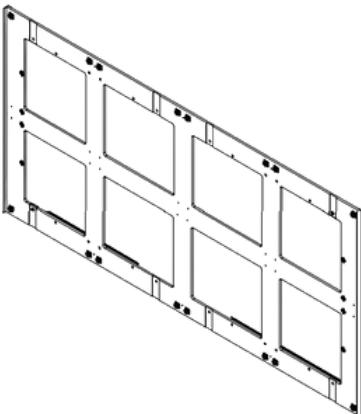
3 X  panel support unit

NOTICE!

The set includes 12 panels and can be mounted vertically (160x240 cm) or horizontally (240x160 cm).

The product does not come with wall screws - different types of walls require different types of fasteners; always use screws and bolts suitable for the walls in a given room.

1 MOUNTING THE SUSPENSION RAILS TO THE WALL

- Mount the suspension rails parallel to each other, use a level or a similar tool during installation.
- The suspension rail must not be deformed. After mounting it to the wall, make sure if the wall surface is flat.

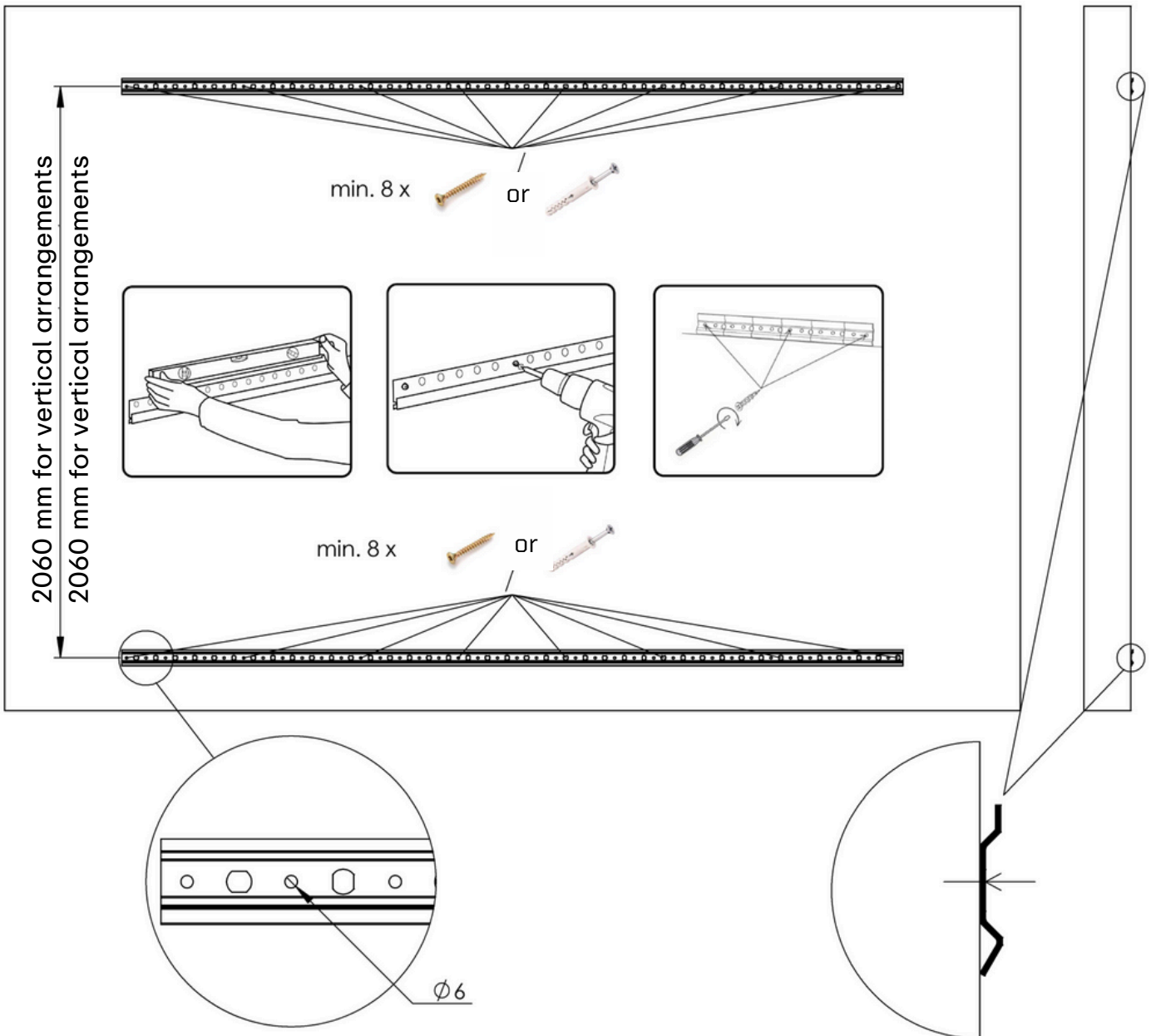

2 MOUNTING AND HANGING PANEL SUPPORT UNITS ON RAILS

VERTICAL
ARRANGEMENT

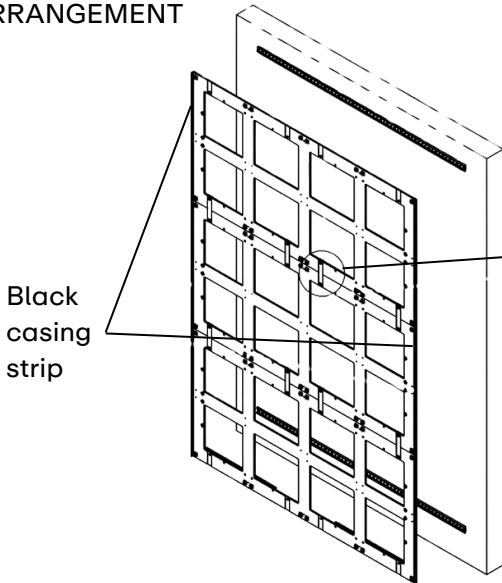

HORIZONTAL
ARRANGEMENT

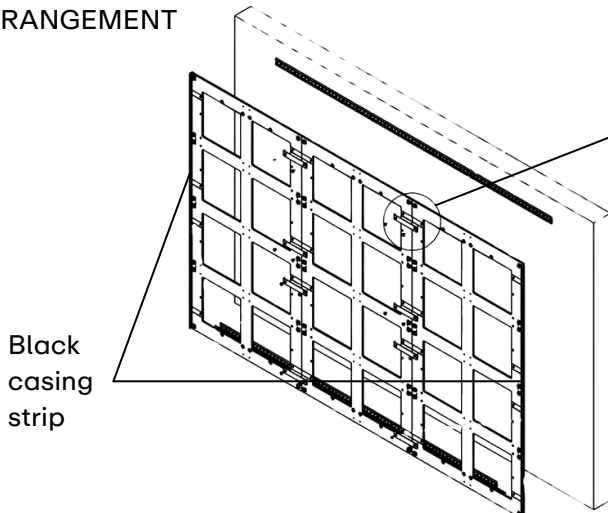

a) Installation of connectors.

8 X



16 X

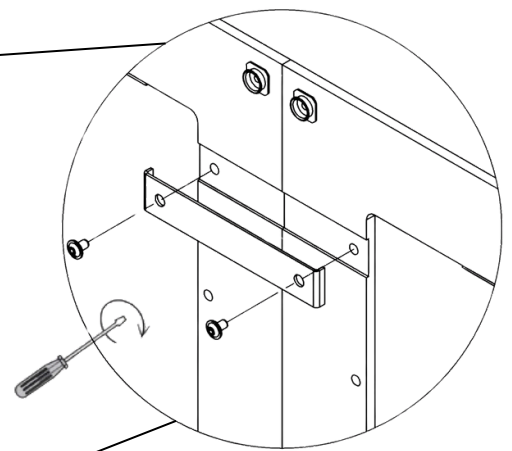

b) Hanging panel support units on rails on the wall.

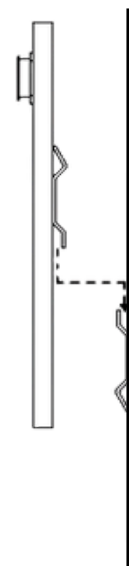

NOTICE!

Mount the support units with the black casing strips facing outward. These strips will remain visible after panel installation.

3 INSTALLATION OF PANELS

Mount the panels individually to the support units.

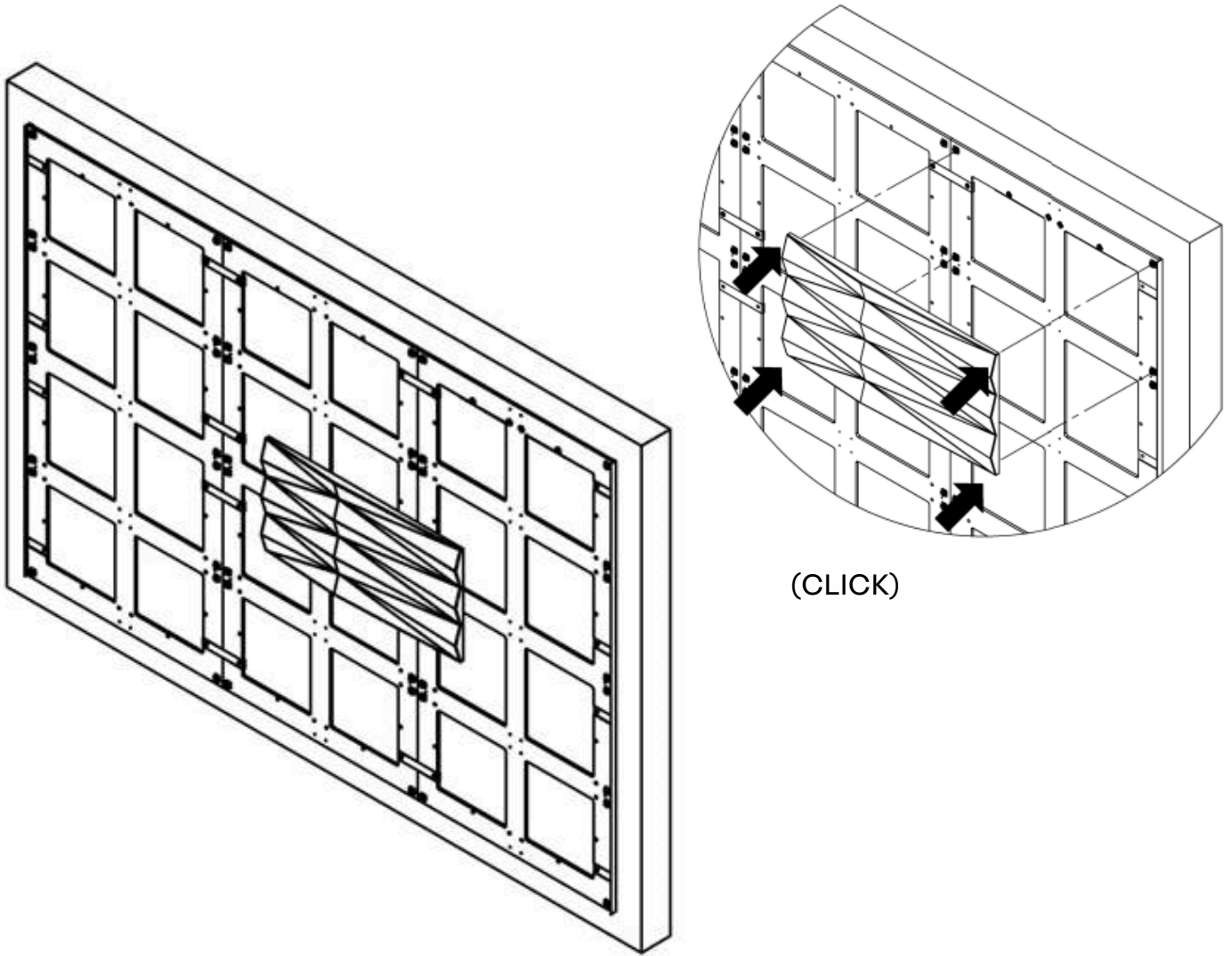

VERTICAL
ARRANGEMENT

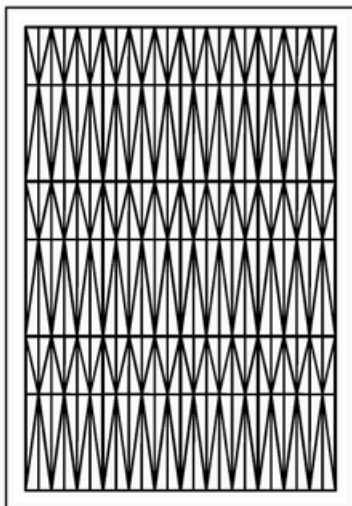

HORIZONTAL
ARRANGEMENT

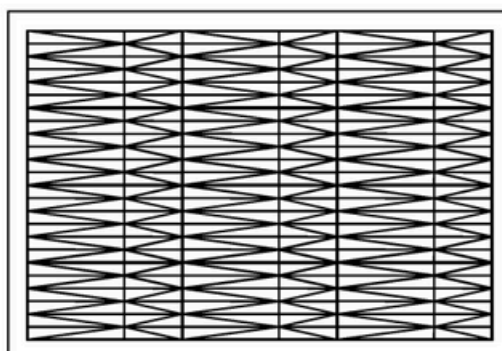

Funky Circular Interior Objects

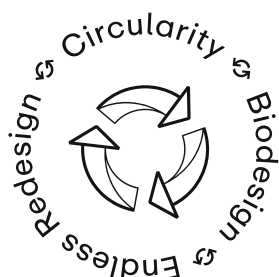

VANK is a team of architects, engineers, and artisans. We create furniture. Objects. Tangible signs in space. Items designed intelligently, with respect for the natural environment, and manufactured using the latest technologies. We believe in a circular economy model that limits the consumption of natural resources by increasing the use of renewable, bio-based or recycled materials.

www.vank.design

VANK